

Control

xzense



UK | Read and save these instructions!

exodraft
Your energy. Optimized.

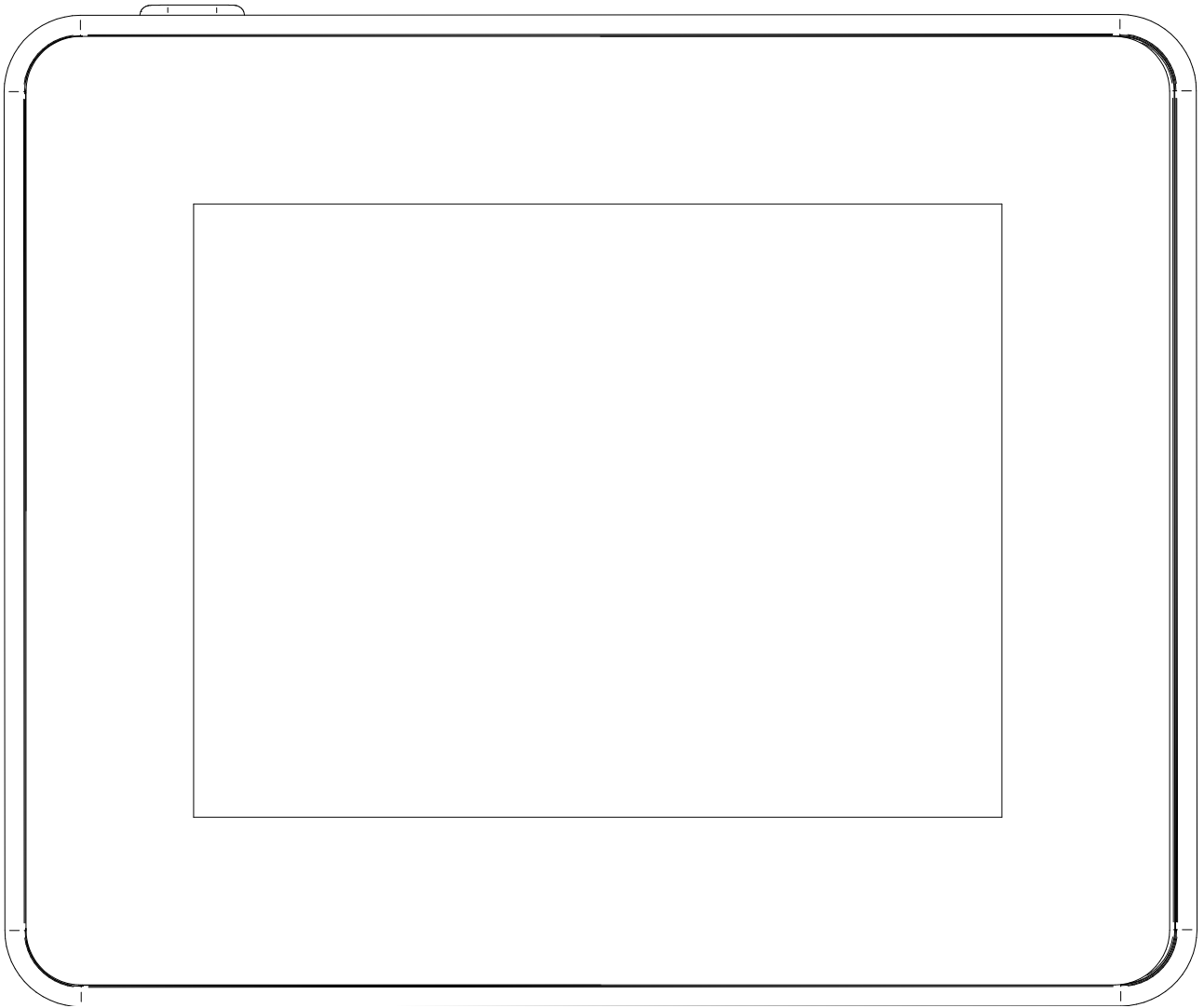

If you want to have an overall view of yours units' ID number and password, they can be written down here..

**The serial number is located on the back of the control panel.*

Type	ID no.	Password	Serial number
Pairing card (pin code)			
Power Unit ID			
Control panel serial no.*			

Control | Xzense

Content

Product information	7
Scope of supply	7
Accessories and spare parts	7
Function - with temperature sensor activated	9
Function - with temperature sensor deactivated (ventilation)	9
Warranty	10
Setup and mounting	11
Mounting of sensor and Power Unit	11
Wiring diagram	13
Mounting of control panel	13
Generally add/delete devices	16
Add/pair with Power Unit	18
Test of communication/signal	23
Signal test	24
Language selection	25
Lighting and operation	26
Refire and Afterrun	27
Turn off the chimney fan	27
Ventilation	28
Weather station	29
System control	29
eXotelligence	30
Pairing with smartphone via Bluetooth	32
Basic features of the app	38
Ventilation with the app	42
Weather station in the app	43
Setup and history in the app	44
Accessories - Repeater	52
Accessories - XTP sensor	54
Technical specifications	56
Troubleshooting	56
User and service menu	58
UK Conformity Assessed	60
Declaration of Conformity	61



How to use this manual

This manual has been prepared based on the specific product and contains relevant technical information and installations guides.

Accessories and spare parts are not covered by this manual. Please refer to the individual manuals of these components.

This installation manual does not contain any system design documentation.

Failure to observe instructions marked with a danger symbol may result in personal injury and/or damage to the product.

Errors and omissions excepted.



Disposal

Electrical and electronic equipment (EEE) often contain materials, components and substances that may harm the environment or be hazardous to your health. Products (WEEE) marked with the 'crossed-out wheeled bin' symbol should be disposed of separately from other waste at the end of its life. Though legislation may differ from country to country we strongly advise that electrical and electronic waste is separated from other waste and disposed of according to national legislation to protect the environment and personnel that may come into contact with waste.

Symbols

The following symbols may be used in the manual to draw attention to danger or risk of personal injury or damage to the product.



General prohibition

Failure to observe instructions marked with the prohibited symbol may result in extreme danger or serious personal injury.



General attention

Marks a dangerous situation that, in the worst-case scenario, can cause serious personal injury or significant damage to the product.



General warning

Failure to observe instructions marked with a danger symbol may result in personal injury and/or damage to the product.



Electricity hazard/High Voltage

Marks a situation in which caution is advised due to the risk of high voltage electric shock which can cause serious personal injury or significant damage to the product.



Connect an earth terminal to the ground

Failure to observe instructions marked with a danger symbol may result in personal injury and/or damage to the product.



Permitted and approved

Permitted and approved method of installation.



Prohibited and not approved

Prohibited and not approved method of installation.



Warning

To minimise the risk of fire, electric shock, personal injury and/or damage to the product please observe the following:

- Please always read the manual and only use the product in accordance with the manufacturer's instructions. If in doubt, contact one of the Exodraft specialized dealers.
- All installations must be carried out by properly qualified personnel in accordance with national legislation and regulations.
- This product must be earthed. Get assistance from an qualified electrician when in doubt.
- This product must always be disconnected under the installation.
- Prior to servicing the product, disconnect the power and ensure that it cannot accidentally be reconnected.
- Exodraft always recommends the use of a smoke alarm when a solid fuel open fire is installed.
- If the Exodraft fan system has been designed for solid fuel/multi fuel installations, please ensure that the design meets the requirements of BS EN15287-1. If this cannot be achieved, a smoke alarm must be installed in the same room as the heat appliance.

Product information

Exodraft wireless Xzense control, together with an Exodraft chimney fan, is designed for use with fireplaces, stoves and solid fuel boilers.

Xzense can start the chimney fan by using the control panel, but it can also be started automatically by means of the temperature sensor.

The temperature sensor monitors the fireplace and informs when to add more fuel. When the temperature drops further, the chimney fan stops after 30 min. A simple programming of the control makes it possible to use Xzense optimally, together with either an open fireplace or a stove/boiler.

Xzense also allows you to warn against excessive temperature in the chimney.

Xzense can be used to regulate the chimney fan, even without heat in the fireplace, if it is desired to ventilate the room.

Scope of supply

- Xzense control panel
- Power unit for mounting on chimney
- Temperature sensor
- Bracket / wall mount
- Bag with two rawl plugs and two screws for fitting
- USB micro charging cable
- USB-C to USB-A adapter
- 5V IA USB charger
- Installation instructions and Quick guides
- Pairing card (pin code) with code for pairing control panel and control box

Accessories and spare parts

The table below shows the accessories and spare parts available for the Xzense.

Exodraft item no.	Accessorie item*	Description
7501001	Repeater	If there is a need to have a Power Unit and Control panel located at a distance that excludes signal between the units, it is possible to amplify the signal with a repeater.
7501002	XTP-sensor (Pressure sensor)	With a wireless XTP sensor, it is possible to keep a constant draft in the chimney without having to adjust the speed of the chimney.
7501004	USB-charger	If there is a constant supply for the control panel, for example. In connection with operation via an App from a smartphone, this requires a USB charger.
1100703	Fittings for mounting on the steel chimney	If the Power Unit is to be mounted on a steel chimney, a mounting kit can be purchased.
5220000	Additional control panel	If you want to be able to control the chimney fan from several fireplaces, several control panels can be connected to the same system.

*This manual does not describe the specific use of accessories. We refer to the separate manuals for such components.

For more details contact your Exodraft dealer.

Technical data

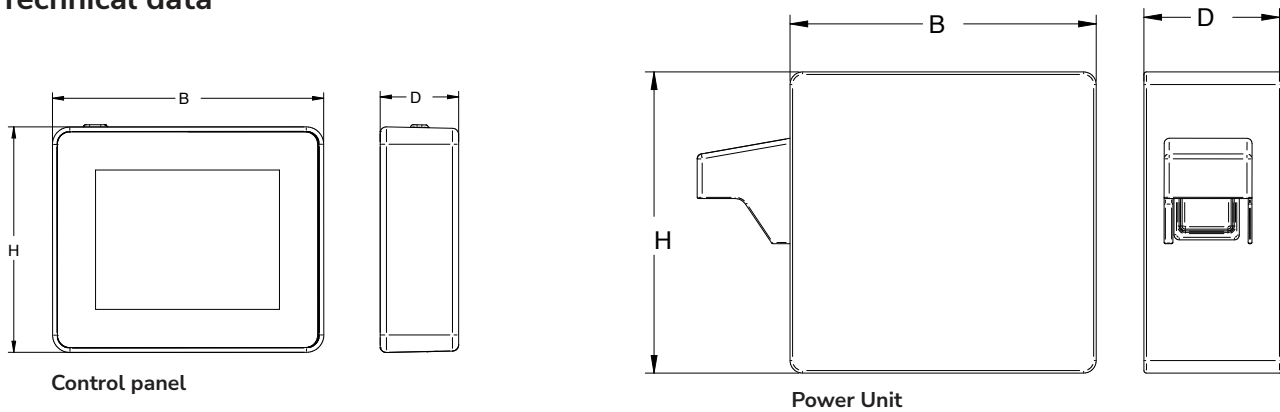

Data	Control panel	Power Unit	Temperature sensor
Dimensions H x B x D [mm]	72 x 86 x 25	122 x 120 x 55	ø6 x 200
Voltage	5 V (USB)	230 V ± 10 % / 50 Hz	
Protection	IP20	IP54	
Material	ABS	PC	Stainless Steel
Ambient	0 °C to 40 °C	-30 °C to 60 °C	Sensor: -50 °C to 300 °C Cable: -50 °C to 125 °C
Frequency for radiocommunications	868 MHz	868 MHz / Bluetooth LE 2.4 GHz	
Battery type	Li-Po Battery		
Battery life	30 days (preliminary)*		
Fuse		T 2,0 A	
Power output		2 A	
Standby consumption		1 W	
Type			PT 1000

*The control panel has a service life of approx 30 days of normal use with deactivated bluetooth communication for a smartphone. It is recommended that the control panel charger plug is always used when Bluetooth is enabled, as battery life is significantly reduced by using the smartphone and the Bluetooth function.

Function - with temperature sensor activated

Start-up function

Xzense is activated by pressing the button at the top of the control panel. The lighting function is selected before lighting the stove/fireplace. The chimney fan now starts at the starting speed *boost*. After a preset time, the speed is adjusted down to a lower set level.

The factory setting for boost speed is 100% for 10 min. The first time the Xzense is used the speed drops to 50 %. When used the next time, the speed drops to the last used speed.

Automatic startup

If you forget to start the chimney fan before lighting, the chimney fan will automatically start when the temperature reaches the set start temperature at the sensor.

The factory setting is 40°C.

Refiring function

The Xzense control panel indicates when it is time to add new fuel. The display lights up and a dialog box comes up while giving an alarm beep. If you want to refire, select the YES button. Then you refire further by adding more fuel. When you say YES to refiring, the chimney fan creates a maximum boost for 3 minutes, after which it regulates the speed down again.

Automatic stop

After the last firing, the temperature of the chimney will slowly drop. When the temperature has dropped to the factory default setting, the controller ensures that the chimney fan stays in operation for a while, to ensure that the last smoke is pulled out, also called *afterrun*. The factory setting for *afterrun* is 30 min.

High temperature warning

The control panel display will light up if the temperature of the temperature sensor exceeds the set value. The factory setting is 250°C.

All factory settings can be changed and is found under the *Setup* menu.

Function - with temperature sensor deactivated (ventilation)

Ventilation

If the temperature sensor is not activated in the user menu, the control can be used as a 10-100% regulation of the speed of the chimney fan. Thereby ventilation from the room can be achieved.

Note! Automatic start and stop is also disabled if the temperature sensor is disabled.

Warranty

All Exodraft products are covered by a 2-year guarantee as per European consumer rights legislation. For some countries an extended period of guarantee may apply depending on either national legislation or other clearly stipulated conditions. Customer complaints must be handled by a specialised dealer or wholesaler (preferably where the Exodraft product has been bought originally). An updated list of Exodraft specialised dealers can be found on our website for the country in question.

Exodraft products must always be installed by properly qualified personnel. Exodraft reserves the right to change these guidelines without prior notice.

The warranty and liability does not cover instances regarding personal injury or damage to property or the product that can be ascribed to one or more of the following causes:

- Failure to follow this installation and operation manual
- Incorrect installation, start-up, maintenance or servicing
- Improper repairs
- Unauthorised structural modifications made to the product
- Installation of additional components that have not been tested/approved with the product
- Any damage resulting from continued use of the product despite an evident defect
- Failure to use original spareparts and accessories
- Failure to use the product as intended
- Exceeding or failure to meet the limit values in the technical data
- Force majeure

Setup and mounting

Sending signals

Place the Power Unit on the chimney so that the most direct line can be reached.

The Power Unit and the chimney fan must have a maximum distance of 1 meter, so that the cables can reach.

Range

The range between the units should not exceed 18 meters if you want the most optimal signal. Please note that some building constructions may result in a shorter range. This could for example be steel reinforced concrete. Wireless devices with the same frequency may also reduce the range.

Signal

The Xzense repeater can extend the working distance between the Power unit and the control panel. This is useful when the signal shall pass through several storeys.

The signal can at most go through 3 pcs. repeater between an Xzense Power Unit and a control panel. The repeater is placed between the Xzense control panel and the Power Unit, which is typically mounted on the chimney.

In some situations, it would be appropriate to set up the repeater outdoors, e.g. under the overhang or on another building. The signal may have difficulties penetrating certain materials, such as steel and aluminum structures.

Mounting of sensor and Power Unit

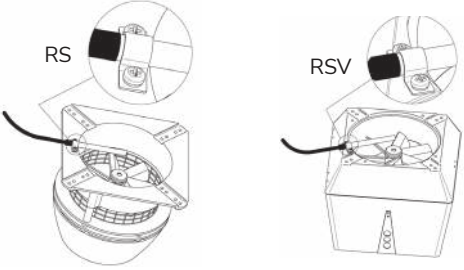
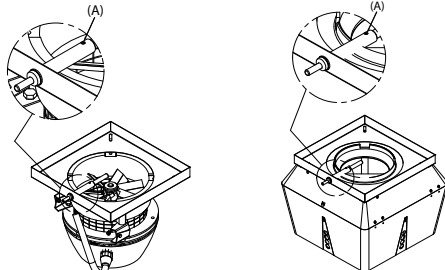
Step	Action	Illustration
1a	Install the sensor on the chimney fan with the supplied bracket. Drill 2 pcs. 4 mm holes and insert the screws.	
1b	Mounting with cover flange: Remove the plug from the tube cover flange, and insert sensor. Tighten the screw (A).	

Step	Action	Illustration
2a	<p>For brick chimneys: Drill holes as shown (max. 1 m from the chimney fan). Remove the lid from the power unit and mount it on the chimney using rawlplugs and screws.</p> <p>Note: Position the device where it has the best line of sight to the control panel.</p>	
2b	<p>For steel chimneys: Remove the lid from the power unit and mount the bracket (optional extra) using screws and nuts. Drill 4 mm holes in the chimney and mount the device using selftapping screws (max. 1 m from the chimney fan).</p> <p>Note: Position the device where it has the best line of sight to the control panel.</p>	
3	<p>Connect the wires according to the diagram at the bottom.</p> <p>A - Supply voltage (cable with plug attached).</p> <p>B - Connection to a chimney fan.</p> <p>C - Building automation</p> <p>D - Connection to temperature sensor.</p> <p>When installing cables, wires should be approx. 8 cm free of the jacket.</p> <p>Note: There must be no power on the device when connecting wires.</p>	
4	<p>Attaching armoured hose from chimney fan.</p> <p>Remove the screw connector from the armoured hose. Keep the small plastic clamping ring!</p> <p>E - Fit the nut from the connector from the power unit.</p> <p>F - Fit the plastic clamping ring on the armoured hose.</p> <p>Attach the armoured hose to the power unit.</p>	

Wiring diagram

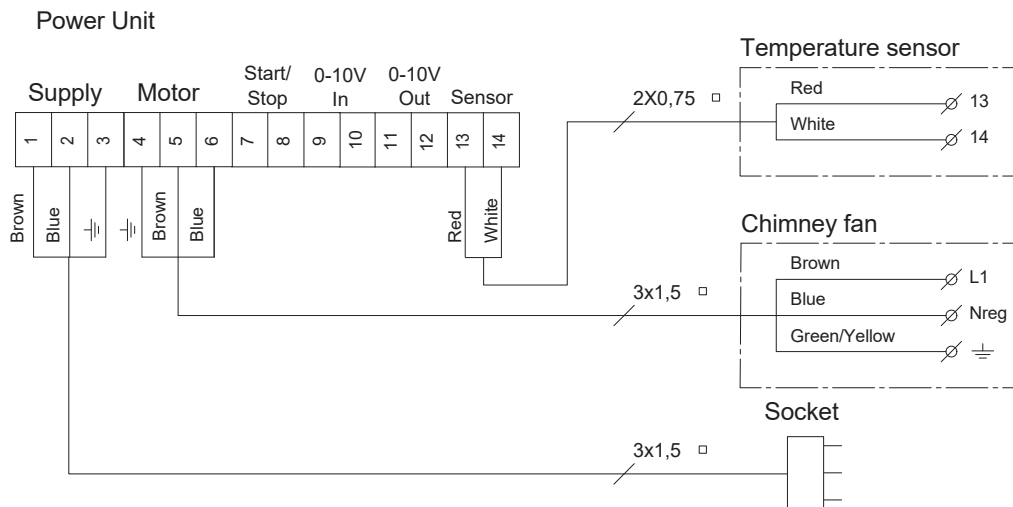



Mounting of control panel

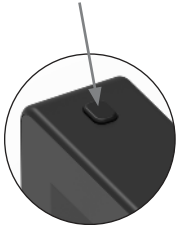
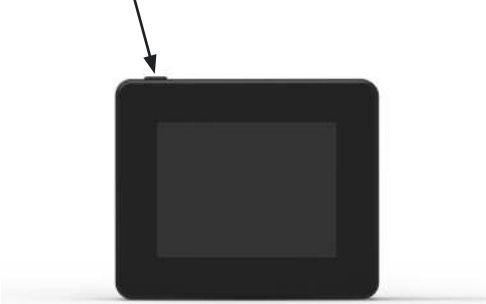

Step	Action	Illustration
1	<p>Mark the distance on the wall from the steel plate.</p> <p>Drill 2 holes with a diameter of 6 mm Insert rawplugs and mount the steel plate in the two holes with two screws.</p>	
2	<p>Slide the plastic bracket outside the steel plate</p>	
3	<p>Fit the stop at the end of the bracket</p> <p>The Xzense control panel can now be placed on the wall bracket</p>	

General use of the control panel

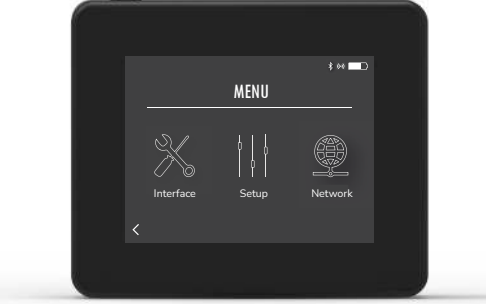
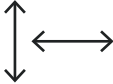
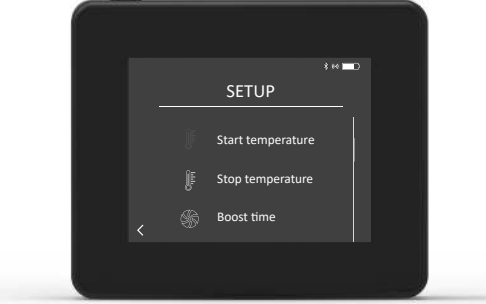
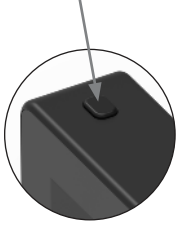
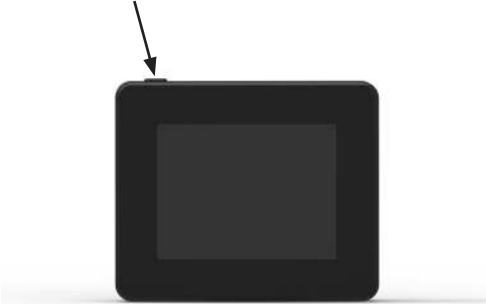
Function of buttons and touch screen





Action	Illustration	Example
<p>Display activation Press the button on the top with one click to activate the display. The control panel is activated when it lights up.</p> <p>The control panel goes into standby/sleep by pressing the button once more while the display is on. After approx 10 seconds, the display will even go into sleep if there is no activity on the display.</p>		
<p>Tap lightly Tap a finger to navigate the menus, or to change the values of the Settings.</p>		
<p>Scroll Move a finger (up/down or to the sides) across the screen without lifting it, to scroll up and down/back and forth in the respective drop-down menus.</p>		
<p>Restart or switch off the control panel To restart the control panel, hold down the button for approx 4 sec. A dialog box appears and asks if you want to restart the control panel.</p> <p>If you want to switch off its panel completely, press the button for more than 10 sec. To reactivate the panel, it needs to be powered by a USB-charger.</p>		

Charging and battery

Action	Illustration	Example
<p>Charging with USB cable To charge the control panel, use the USB connector at the bottom. A charge from the entire discharged state takes approx 4-5 hours.</p> <p>The control panel has a service life of approx 30 days of normal use with deactivated bluetooth communication for a smartphone*.</p> <p><i>*It is recommended that the control panel charger plug is always used when Bluetooth is enabled as the life of the battery is significantly reduced when using the smartphone and the bluetooth function.</i></p>		

Generally add/delete devices

Add devices

Step	Action	Display
1	<p>To add a device (Power Unit, etc.), select the Add Device menu.</p> <p>Note: a repeater shall only be turned on and not connected in UNITS menu.</p>	
2	<p>Already paired devices are displayed on the screen with a trash can beside.</p> <p>To pair with a new device, select a device with a link beside.</p>	
3	<p>If the desired device you want to pair with is not available, you can add the device via code-pairing.</p> <p>Select the Add Device feature +.</p> <p>Note: the power unit must be turned on.</p>	
4	<p>If you want to pair with a Power Unit, you must enter the correct code from the pairing code card that came with the Power Unit.</p> <p>Use the arrows to navigate the numbers and use the plus and minus icons to increase or decrease the value of the number. Finish with OK.</p>	
5	<p>The code consists of four characters. Number from 0-9 and/or letters from A-F.*</p> <p>*The password illustrated to the right is just an example.</p>	

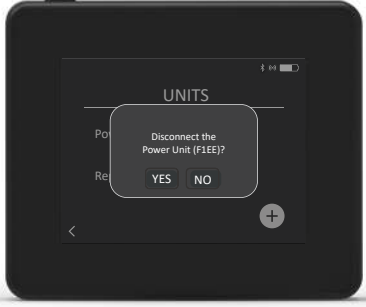

Delete paired devices

Step	Action	Display
1	If you want to delete a paired device, select the trash can icon to delete the pairing.	 A screenshot of a tablet displaying the 'UNITS' screen. The screen has a dark background with white text. At the top, it says 'UNITS' with a signal strength indicator and battery icon on the right. Below this, there are two entries: 'Power Unit (F1EE)' with a trash can icon to its right, and 'Repeater' with a link icon to its right. At the bottom left is a back arrow, and at the bottom right is a plus sign in a circle.
2	A dialog box appears, and you finally confirm with YES if you want to delete the pairing to the device.	 A screenshot of the same tablet displaying the 'UNITS' screen. A dialog box is overlaid in the center. The dialog box has a dark background with white text that reads 'Disconnect the Power Unit (F1EE)?'. Below the text are two buttons: 'YES' and 'NO'. The background screen is dimmed.



Add/pair with Power Unit

It is possible to pair the control panel and Power Unit in three different ways.

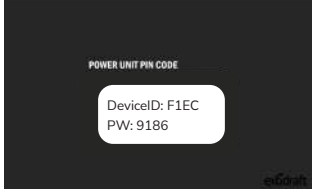

Option 1 - With power within two minutes after power is applied to the power unit

Step	Action	Display
1	<p>Within the first two minutes after the power is connected to the Power Unit, the control panel can be connected without the use of ID or code. The connection can thus be made by using <i>Add device</i>, which is found in the start menu.</p>	
2	<p>Select the Power Unit with the correct ID under units. The ID number can be found on the pairing card enclosed with the Power Unit.</p> <p>Note: If the button in the power unit has been pressed correctly, the chain icon is faded.</p>	
3	<p>If the connection has been made correctly, the control panel will report the pairing again.</p>	

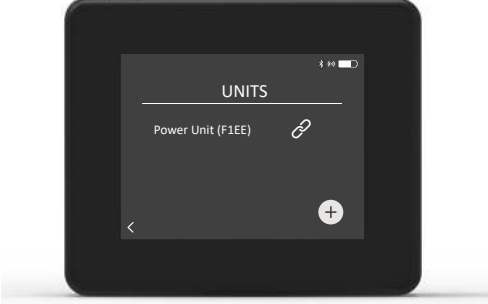
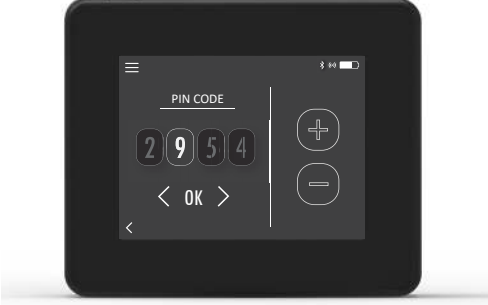
Option 2 - With power and supplied code

Step	Action	Display
1	<p>If the Power Unit has been connected to power for more than two minutes, then the pairing must be done using the password supplied with the Power Unit.*</p> <p><i>*The password illustrated to the right is just an example.</i></p>	
2	<p>The connection can thus be made by using <i>Add device</i>, which is found in the start menu.</p>	
3	<p>Select the Power Unit with the correct ID under units. The ID number can be found on the pairing card enclosed with the Power Unit.</p>	
4	<p>Then enter the supplied code and end with OK. If the connection has been made correctly, the control panel will announce that the pairing has been completed.</p>	

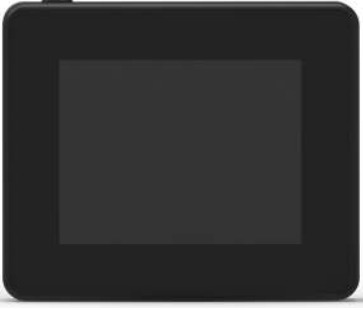
Option 3 - With power and press button in Power Unit

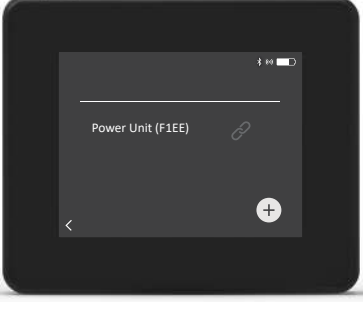
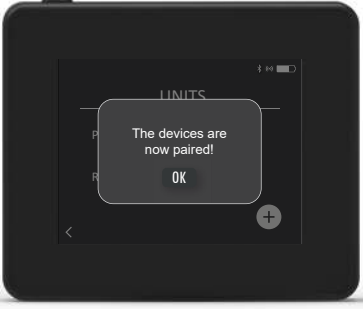
Step	Action	Display
1	If the Power Unit has been connected to power for more than two minutes and the password has been lost, then the pairing can be done by pressing the connection button inside the Power Unit for approx 5 seconds (see illustration on next page - under the <i>Power Unit</i> section).	
2	The connection can thus be made by using <i>Add device</i> , which is found in the start menu.	
3	Select the Power Unit with the correct ID under units. Note: If the button in the power unit has been pressed correctly, the chain icon is faded.	
4	If the connection has been made correctly, the control panel will report the pairing again.	



Power Unit

Features

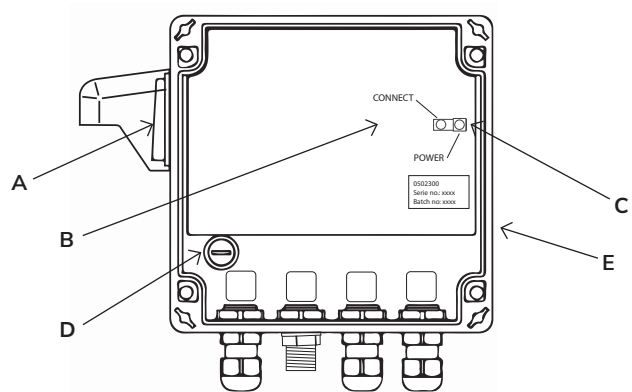

- A Isolation switch for the chimney fan.
- B LED indicators:
POWER lights up continuously when voltage is applied to the Power Unit.
CONNECT lights up when searching for a device.
- C Button to connect:
 The control panel and Power Unit can be connected.
 Press the button (C) on the Power Unit for more than 5 sec.
- D Fuse:
 Secure the chimney fan against overload.
- E The Power Unit serial number (located on the inside of the box)

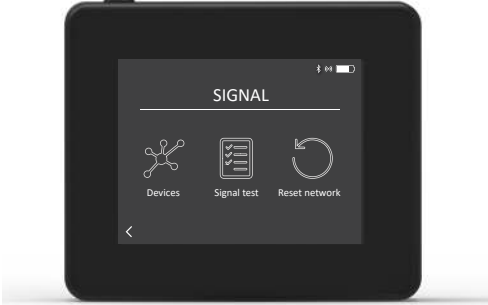

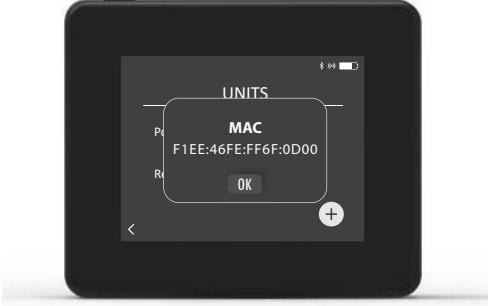

Power Unit MAC address

Step	Action	Display
1	Go to the <i>Devices</i> menu in the <i>Signal</i> menu.	 A tablet screen displaying the 'SIGNAL' menu. At the top, it says 'SIGNAL' with a signal strength indicator and battery icon. Below the title, there are three icons: a network diagram labeled 'Devices', a document with a checkmark labeled 'Signal test', and a circular arrow labeled 'Reset network'. A back arrow is visible in the bottom left corner.
2	<i>Long press</i> on the Power Unit.	 A tablet screen displaying the 'UNITS' menu. At the top, it says 'UNITS' with a signal strength indicator and battery icon. Below the title, there are two items: 'Power Unit (F1EE)' with a trash can icon, and 'Repeater' with a link icon. A plus sign icon is in the bottom right corner. A back arrow is visible in the bottom left corner.
3	Then the MAC address will be shown on the display. Press OK to return the <i>Devices</i> menu.	 A tablet screen displaying the 'UNITS' menu. A pop-up window is shown in the center with the title 'UNITS' and the text 'MAC' followed by the address 'F1EE:46FE:FF6F:0D00'. Below the address is an 'OK' button. A plus sign icon is in the bottom right corner. A back arrow is visible in the bottom left corner.

Test of communication/signal

Step	Action	Display
1	<p>Turn on the control panel by clicking the button on the top.</p> <p>Plug in the USB-cable if needed.</p>	
2	<p>The screen now lights up on the home screen.</p> <p>If the display shows the text "No connection to Power Unit", there is no communication between the power unit and control panel. Try moving the control panel for better contact.</p> <p>See the section on Setup - Mounting, for more information.</p>	
3	<p>Good mounting position</p> <p>If you want to mount the wall bracket in order to have a station for the control panel, it must be ensured that the unit can receive signal from this location.</p> <p>Always check if there is a signal before mounting, by pressing the signal icon under the Signal Test.</p>	





Signal test

Step	Action	Display
1	<p>To test the signal strength, enter the Signal Test menu, which is available using the following menu:</p> <ol style="list-style-type: none"> 1. General 2. Network 3. Communication 4. Signal test 	
2	<p>Press the signal icon and the test starts. The power unit sends 100 packets to the control panel, and the result of this transmission can be seen after in the bottom of the screen.</p> <p>If there are many data packets left, the signal is bad and you should find a better place for its control panel.</p> <p>CRC = Number of packets with CRC error LOSS = Number of packets lost RSSI = Received Signal Strength Indicator PER = Packet Error Rate</p> <p>100 = Good 1 = Bad -20 = Good signal -100 = Bad signal</p>	





Language selection

At factory settings, english is selected as the default setting.

It is possible to change the language in the menu, for the control panel.

Step	Action	Display
1	Turn on the control panel by clicking the button at the top. Select the top menu General.	 <p>The image shows the Xzense control panel main menu. At the top, there is a hamburger menu icon on the left and a battery status icon on the right. Below the 'Xzense' logo, there are three large icons: 'Lighting' (a fan), 'Ventilation' (a fan), and 'Weather' (a thermometer).</p>
2	Select the menu Interface	 <p>The image shows the 'MENU' screen. At the top, it says 'MENU'. Below, there are three icons: 'Interface' (a wrench and screwdriver), 'Setup' (two vertical sliders), and 'Network' (a globe). A back arrow is visible in the bottom left corner.</p>
3	Select the menu Language	 <p>The image shows the 'SETTINGS' screen. At the top, it says 'SETTINGS'. Below, there are four icons: 'Language' (a globe), 'Contrast' (a circle with a diagonal line), 'Brightness' (a sun), and 'Sound' (a speaker). A back arrow is visible in the bottom left corner.</p>
4	<p>Select the desired language by moving your finger to the side of the language menu. Click on the desired language.</p> <p>To return to the menus, use the back arrow at the bottom left corner.</p>	 <p>The image shows the 'LANGUAGE' screen. At the top, it says 'LANGUAGE'. Below, it says 'DANISH'. There are three language options with their respective flags: 'DA' (Danish), 'SE' (Swedish), and 'NO' (Norwegian). A back arrow is visible in the bottom left corner.</p>

Lighting and operation

Step	Action	Display
1	Select <i>Lighting</i>	
2	<p>The display shows a lighting, and the fireplace/stove must now be turned on.</p> <p>The chimney fan will run at maximum speed for 10 minutes (default setting) and then fall to the speed it was driving when it was last turned on. The Boost period and speed can be changed in the Setup menu.</p>	
3	<p>Turn on while the chimney fan is running at maximum speed.</p> <p>If the temperature sensor is activated and you forget to turn on the chimney before turning on, the chimney fan will automatically start when the temperature at the top of the chimney has reached the start temperature setting. The factory setting is 40 °C.</p> <p>Note: We recommend that the chimney fan shall be switched on manually every time! At the same time you avoid soot and ach to escape the fireplace/stove during lighting.</p>	
4	<p>After the boost period, it switches on in operation mode.</p> <p>To increase or decrease the chimney speed and hence the chimney draft, the up and down buttons are used. The display shows the new setting.</p>	
5	<p>The display automatically goes into sleep mode and the backlight goes out after a short time. Press the button on the top of the unit to turn the display back on.</p>	

Refire and Afterrun

Step	Action	Display
1	<p>When it's time to refuel, the display lights up, a small alarm sounds and a dialog pops up and asks if you want to refuel.</p> <p>It is possible to turn on the alarm signal in the menu <i>Settings</i>.</p>	
2	<p>If you want to <i>Refire</i>, press <i>YES</i> in the dialog box before refire.</p> <p>In order to avoid soot and smoke in the room, the chimney fan speed is increased to maximum (boost) for 3 minutes before decreasing back to the previous setting.</p>	
3	<p>If you do not want to re-fire, <i>NO</i> is selected and the <i>Afterrun</i> will start.</p> <p>The afterrun has a factory setting of 30 minutes.</p>	

Turn off the chimney fan

Step	Action
A	<p>Ventilation: The chimney fan is switched off by pressing the switch off.</p> <p>Note: If the temperature sensor is activated, the chimney fan cannot be switched off as long as the temperature at the chimney fan is higher than the stop temperature setting.</p>
B	<p>Automatic: After the last refiring, the temperature in the chimney falls slowly. If the temperature sensor is activated the chimney fan automatically stops when the temperature in the chimney has fallen below the stop temperature. The factory setting is 35 °C.</p> <p>The chimney fan has a Afterrun period of 30 minutes, which ensures that the fuel is glow-free and that the remaining smoke has been led away from the chimney. Both the stop temperature and the afterrun period can be changed in the menu.</p>

Ventilation

The chimney fan can also be used when there is no fire in the fireplace/stove.



The chimney fan can ventilate the room or make sure that soot and dust particles are sucked away while the fireplace is being cleaned.

When the chimney is swept, the chimney fan must also be cleaned.

Step	Action	Display
1	Select the function Ventilation, to make a ventilation without a lighting.	
2	Start the chimney fan by press the Start-button.	
3	To increase or decrease the speed, use the buttons to adjust with. The display shows in percentage how fast it is running. Turn off the chimney fan by pressing Stop.	



Weather station

In the weather station on the control panel you can see the conditions for the weather on the given day/ firing.

Type	Icon	Description
Outdoor		The Power Unit has a built-in temperature sensor, which is used to indicate the outdoor temperature on the control panel. Since the Power Unit can be exposed directly to the sun, the measured temperature can differ from the correct measured ambient temperature.
Chimney		The supplied temperature sensor for installation under the chimney fan is used to indicate the flue gas temperature.
Air pressure		The Power Unit has a built-in air Pressure Sensor designed to measure atmospheric pressure. The pressure is measured in hPa.

System control

The control panel can be set for various control systems - manual use, exotelligence or pressure control.

Type	Icon	Description
Manual		By manual use, you manually adjust the speed of the chimney fan during operation. This means that after the boost period, the chimney fan runs down to the last used operating speed and stays there until the control panel is adjusted. It can be regulated within the range of 10-100%, depending on how much feature you want to create.
eXotelligence*		eXotelligence is an intelligent function that creates data measured in the control after one or more firings. This function ensures that it is the most optimal ignition and operation, based on how you have previously switched on and operated. Turning this function on enables the controller to drive the speed up and down, depending on the indoor and outdoor temperature, air pressure and chimney temperature. For eXotelligence to work, it requires the Power Unit to be outdoors and not directly in sunlight.
Pressure controlled		To be able to operate in Pressure Controlled mode, a Xzense wireless XTP sensor needs to be added to the system. When operating in Pressure Controlled mode the system regulates the fan automatic to the desired draft adjusted in the settings menu.

* Read more about eXotelligence on page 30.

eXotelligence

In manual mode the speed of the fan is adjusted by the user, and it is up to the user to make sure that the draft is adjusted when needed. This will work very fine but changing weather and atmospheric pressure over the week has a big influence on the natural draft of the chimney. This can lead to too much draft, which leads to too fast combustion of the wood or too low draft leading to a bad combustion. eXotelligence can help the user of the fireplace to adjust the speed of the fan to compensate for the changing natural draft.

Important! To work correctly, the Power Unit has to be mounted outside.

To activate eXotelligence go to the System Control on the setup menu.

NB! After activating the eXotelligence mode, it is very important to use the fireplace for more than one hour. This is due to the functionality of the eXotelligence function that needs time to measure the temperature in the chimney, the inside temperature and the atmospheric pressure.

The first time the system is used with eXotelligence enabled, the user must adjust the speed of the fan manually. Make sure the flames in the fireplace are not too high and not too small. Use the system as in normal mode and let the fire burn out when no more heat is needed.

When the fireplace is used next time, the eXotelligence system will compare the actual in/outside temperature and the atmospheric pressure. If there is a significant difference, the fan speed will be adjusted accordingly.

The present day

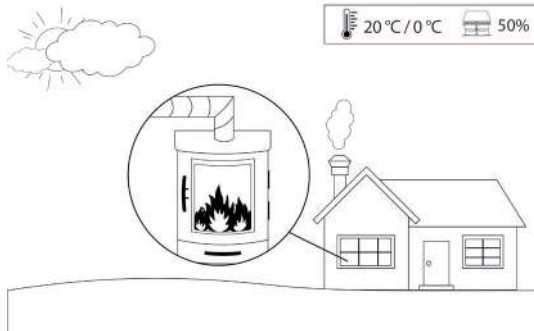

The day before

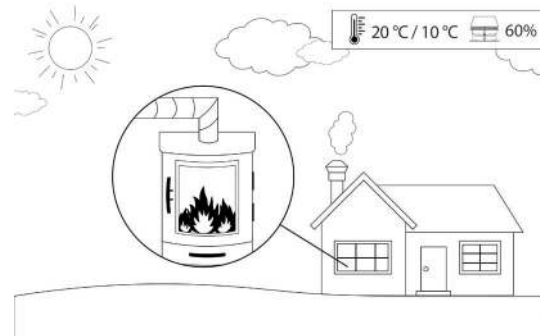

Example 1: The present day the inside temperature is 20 °C and outside 0 °C. The day before the inside temperature was 20 °C and the outside was 10 °C. The air pressure is the same. The difference of the outside temperature will lead to a higher natural draft, and therefore the speed of the fan needs to be decreased 10 % to achieve approximately the same flames as the day before.

The present day

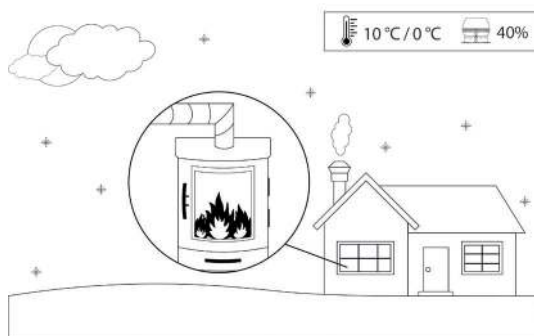

The day before

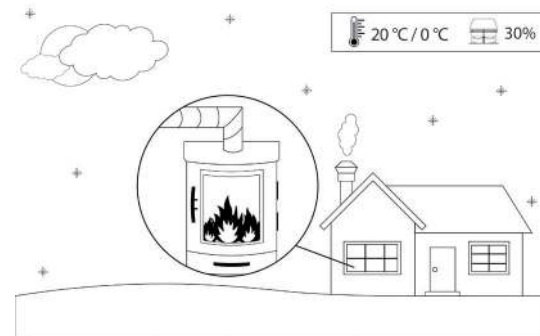



Example 2: The present day the inside temperature is 10 °C and outside 0 °C. The day before the inside temperature was 20 °C and the outside was 0 °C. The air pressure is the same. The difference of the outside temperature will lead to a lower natural draft, and therefore the speed of the fan needs to be increased 10 % to achieve approximately the same flames as the day before.

Pairing with smartphone via Bluetooth

The control panel can be paired with a smartphone (iOS and Android) if you want to operate the chimney by using an app. Download the app Xzense in your application store on your smartphone.

It is recommended to use apply power to the control panel when Bluetooth is enabled, as battery life is significantly reduced when using the smartphone and the Bluetooth function.

Control panel

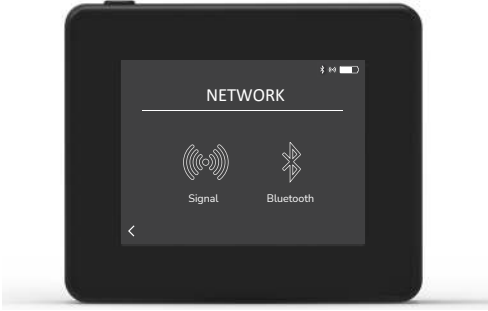
Step	Action	Display
1	Turn on the control panel by clicking the button at the top. Select the <i>General</i> menu in the left corner.	
2	Select the function <i>Network</i>	
3	Select the function <i>Bluetooth</i>	

4

Turn Bluetooth on by pressing the *OFF* button
- It then switches to *ON*.



5

To see the control panels ID and PIN, you can tap the large Bluetooth icon and a dialog box will appear with the information.

Note: The Bluetooth PIN can be changed by pressing the Bluetooth icon and using the < > and +/- buttons

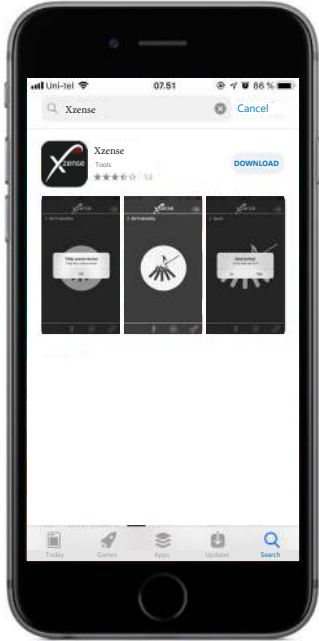
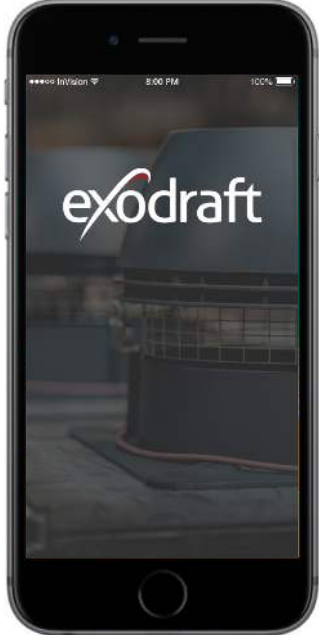

App

Step	Action	Display*
1	Get the Xzense app on your smartphone 	
2	Open the Xzense app on your smartphone	

*On the next pages it is an iPhone that is illustrated, but the app can also be used on an Android smartphone.

- 3 The app will start searching for one Bluetooth connection to your control panel - Remember to turn Bluetooth on both your smartphone and your control panel.

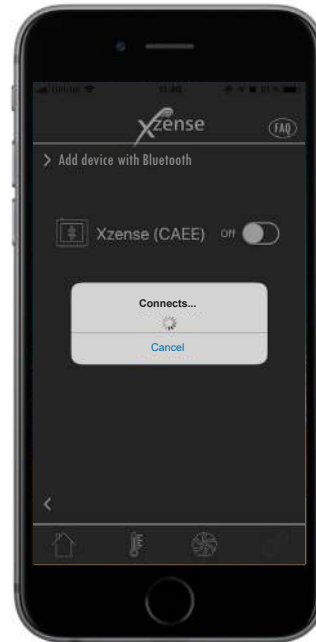

- 4 Select OK to add/pair your control panel with your smartphone.

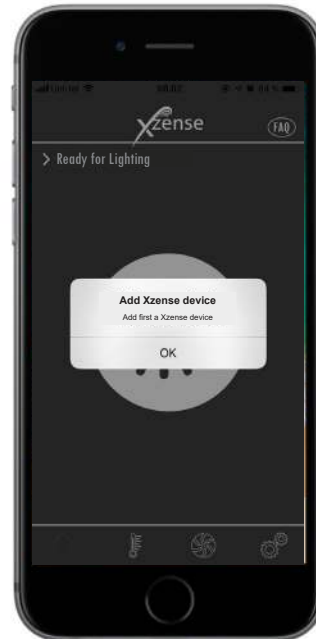

5

Activate the pairing by selecting *ON* on the control panel you want to pair with. The control panel ID is seen in parentheses after the Xzense text. Eg. Xzense (CFEE)



6

Enter the code and finish with OK.

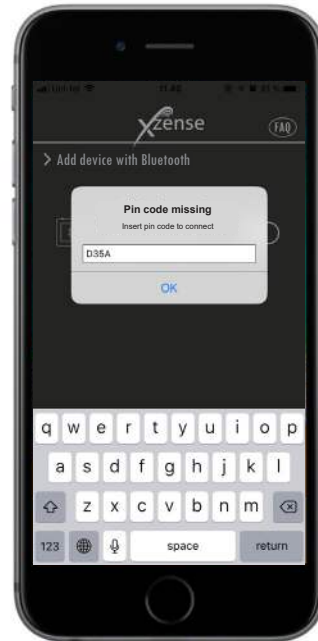

- 7 The app is now paired with the control panel - and you can now make a lighting by using your app.

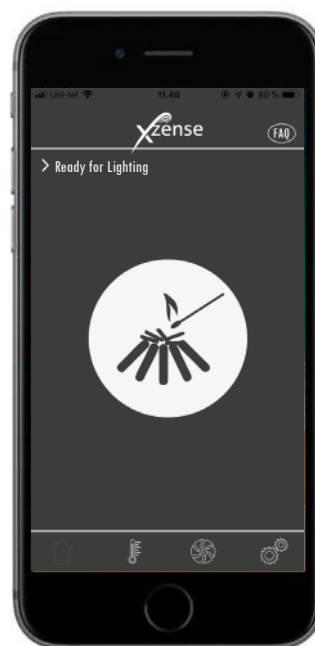

Basic features of the app

Please note that the app's functions can only be used if the control panel is connected. The control panel and app will synchronize with each other along the way.

Lighting

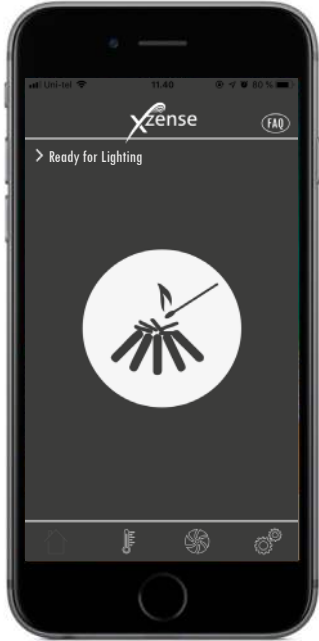
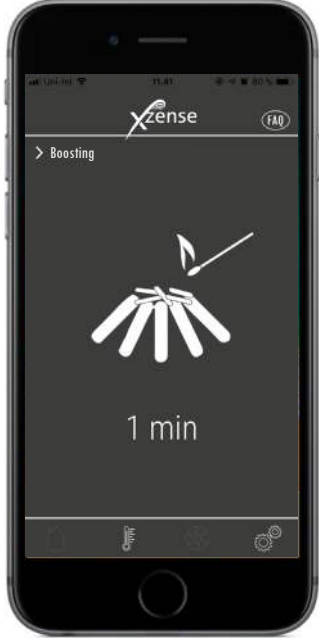
Step	Action	Display
1	Press the lighting icon to start the boost function.	 A smartphone screen displaying the 'xzense' app interface. At the top, it says 'Ready for Lighting' with a right-pointing arrow. Below this is a large white circular icon containing a black silhouette of a campfire with a single stick being lit. At the bottom of the screen, there is a navigation bar with three icons: a chimney, a fan, and a gear.
2	<p>The boost period starts and runs in the time interval the control panel is on.</p> <p>At the factory setting, the boost period is set 10 min.</p> <p>Make sure to turn on during the boost period - ie. when the chimney fan runs at maximum speed.</p>	 A smartphone screen displaying the 'xzense' app interface. At the top, it says 'Boosting' with a right-pointing arrow. Below this is the same campfire icon as in the previous step. Underneath the icon, the text '1 min' is displayed. At the bottom of the screen, there is a navigation bar with three icons: a chimney, a fan, and a gear.

If you wish to stop the lighting, you can click on the lighting icon during the boost period.

- 3 A dialog box appears. Press YES to stop firing.

Press NO if you do not want to stop lighting/firing.

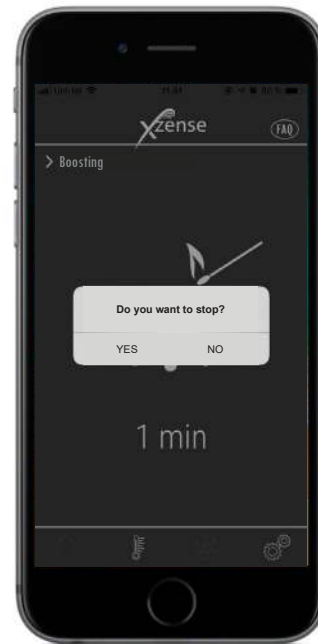

When the boost is finished, the controller continues in normal operation.

- 4 To increase or decrease the chimney speed and hence the chimney draft is used up and down buttons.



Refueling and Afterrun

Step Action

Display

- 1 When it's time to refuel, your smartphone lights up. The control panel also lights up and a small alarm sounds.
- 1 A dialog box appears on both screens and asks if you want to refuel.
- It is possible to turn off the alarm signal on the control panel in the *Settings* menu.

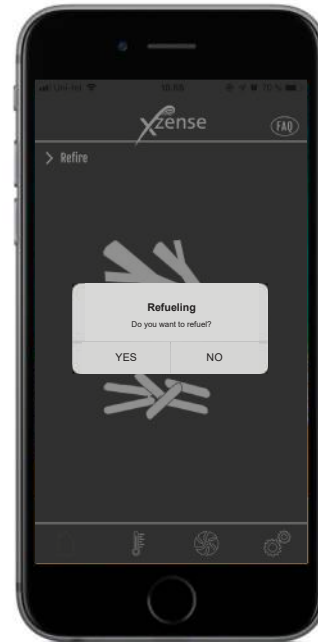

- 2 If you want to refire, press YES in the dialog box before refueling.
- 2 To avoid smokes in the room, increase the chimney fan speed to maximum output in 3 minutes before falling back to the previous setting.

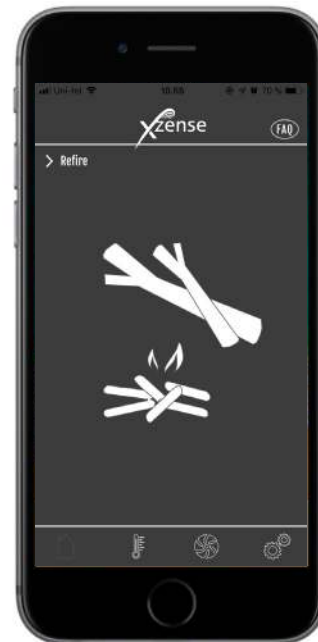

-
- 3 If you do not want to refuel, choose the *NO* function and the Afterrun will start.
- The Afterrun has a factory setting with time period of 30 min.

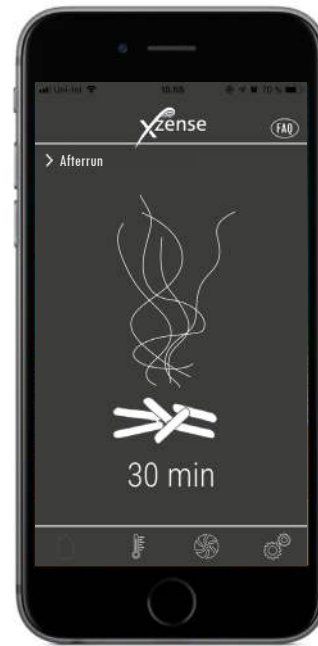

Ventilation with the app

The chimney fan can also be used when there is no fire in the fireplace/stove.

The chimney fan can ventilate the room or make sure that soot and dust particles are sucked away while the fireplace is being cleaned.

When the chimney is cleaned, the chimney fan must also be cleaned.

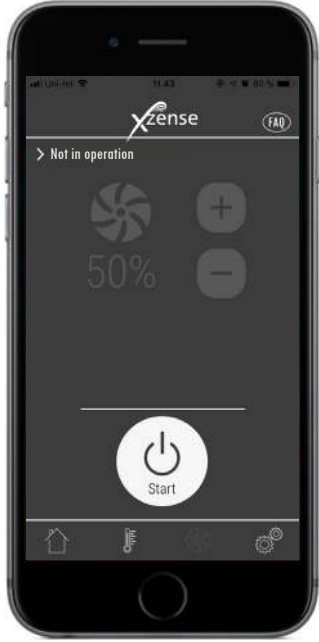
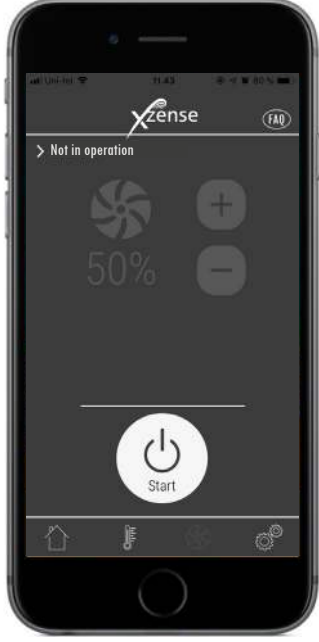
Step	Action	Display
1	Select the <i>Ventilation</i> function to make a ventilation without lighting.	
2	Start the chimney fan by pressing the <i>Start</i> button.	

-
-
- 3 To increase or decrease the speed, use the buttons to adjust with. The display shows in percentage how fast it is running.

Turn off the chimney fan by pressing *Stop*.

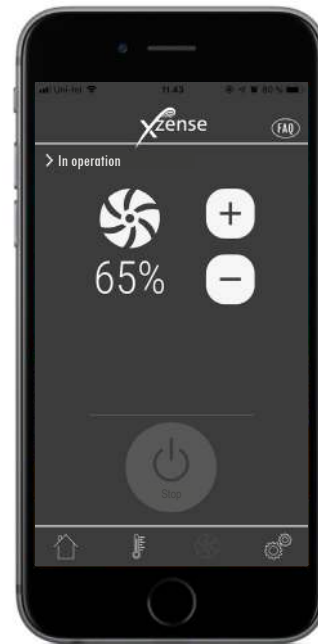

Weather station in the app

Also, as on the control panel, you also have the Weather Station on the app.

Select the *Weather* function at the bottom of the menu to get an overview of temperatures and air pressure at the given time.



Setup and history in the app

Bluetooth

Step Action

Display

1

Select the *Settings* option in the bottom menu.
Select *Bluetooth*.



2

The overview in the Bluetooth menu shows which devices your smartphone can connect to.

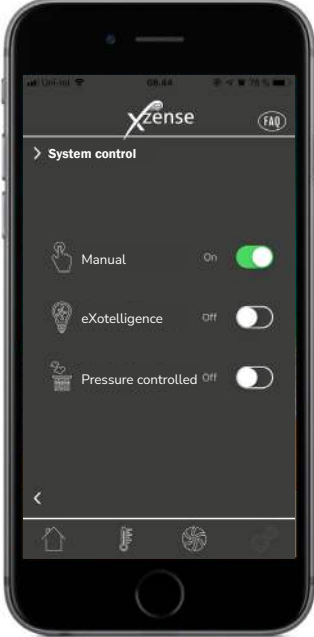

System control

Step	Action	Display
1	<p>Select the <i>Settings</i> option in the bottom menu. Select the <i>System control</i> menu.</p>	 <p>The screenshot shows the Xzense app interface. At the top, there is the Xzense logo and a 'FAQ' button. Below the logo, there are three main menu items: 'Bluetooth' with a Bluetooth symbol, 'System control' with a gear-like symbol, and 'History' with a document and pencil icon. At the bottom, there is a dock with four icons: a home button, a key icon, a gear icon, and a power icon.</p>
2	<p>The screen now shows an overview of which control system the control panel can run with - and which one is selected for the device.</p> <p>To change the control system, this must be done directly from the control panel. See detailed review in "2.12. System control" on page 22.</p> <p>Changing the system control on the control panel will also effect the change on the app.</p>	 <p>The screenshot shows the 'System control' menu. At the top, there is a back arrow and the text '> System control'. Below this, there are three items, each with an icon and a toggle switch: 'Manual' with a hand icon and a green toggle switch (On), 'eXotelligence' with a lightbulb icon and a grey toggle switch (Off), and 'Pressure controlled' with a gear icon and a grey toggle switch (Off). At the bottom, there is a back arrow and the same dock as in the previous screenshot.</p>

History

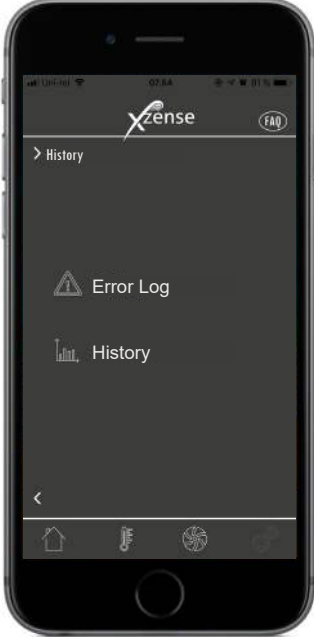
Step	Action	Display
1	Select the <i>Settings</i> option in the bottom menu. Select the <i>History</i> menu.	 A screenshot of an iPhone displaying the Xense app's main menu. The app title 'Xense' is at the top left, and an 'FAQ' link is at the top right. Three menu items are visible: 'Bluetooth' with a Bluetooth symbol, 'System control' with a gear-like symbol, and 'History' with a notepad and pencil icon. A bottom dock contains icons for Home, Xense, System control, and Settings.
2	Choose either <i>Error Log</i> or <i>History</i> to get one overview of any. error messages, operating hours, etc.	 A screenshot of the Xense app's 'History' screen. The title 'History' is at the top left with a right-pointing chevron. Two menu items are listed: 'Error Log' with a warning triangle icon and 'History' with a bar chart icon. A back arrow is at the bottom left. The bottom dock is the same as in the previous screenshot.

History

In the history one can get an overview of the day in hours, the week, the month or the years that have passed.

You can create an overview of the following data:

3

- Temperature outside
- Chimney temperature
- Air pressure
- Chimney fan speed
- Operation hours
- Number of lightings



Error Log

In the Error Log, there is an overview of the error messages that may be have been on the way. The same overview can be found in the control panel.

4

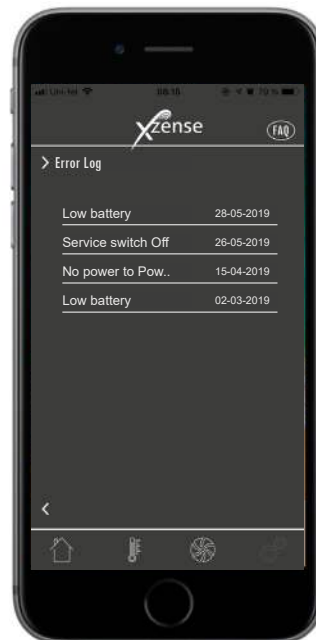

FAQ in the app

In the FAQ in the app you can find the frequently asked questions or small quick guides videos about using Xzense.

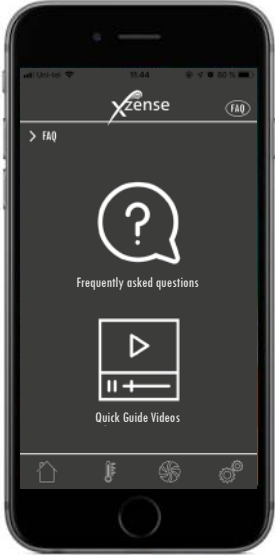
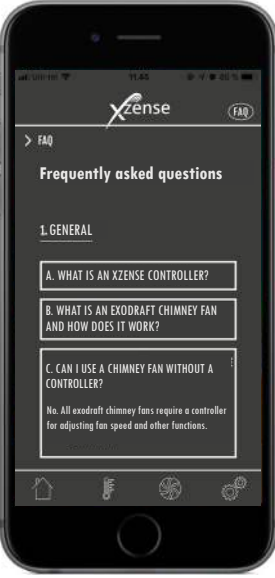
Step	Action	Display
1	Select the FAQ menu in the upper right corner	 A screenshot of an iPhone displaying the Xzense app's home screen. At the top, the Xzense logo is on the left and an 'FAQ' button is on the right. Below the logo, there is a large question mark icon with the text 'Frequently asked questions' underneath it. Below that is a play button icon with the text 'Quick Guide Videos' underneath it. At the bottom, there is a navigation bar with icons for Home, Search, Fan, and Settings.
2	<p>Frequently asked questions Find the frequently asked questions in connection with Xzense. You can find some information on the following:</p> <ol style="list-style-type: none">1. General2. Installation3. Use and maintenance4. Technical specifications	 A screenshot of the Xzense app's FAQ page. The page title is 'Frequently asked questions'. Below the title, there is a section header '1. GENERAL'. Underneath, there are three question cards: 'A. WHAT IS AN XZENSE CONTROLLER?', 'B. WHAT IS AN EXODRAFT CHIMNEY FAN AND HOW DOES IT WORK?', and 'C. CAN I USE A CHIMNEY FAN WITHOUT A CONTROLLER?'. Below the third card, there is a small text block: 'No. All exodraft chimney fans require a controller for adjusting fan speed and other functions.' At the bottom, there is a navigation bar with icons for Home, Search, Fan, and Settings.

Video Guides

For a quick and easy review of:

1. Pairing with Power Unit
2. The use of Xzense (Lighting, Refiring and Afterrun)
- 2 3. Xzense user settings (language, volume, brightness, etc.)
4. Pairing with Smartphone
5. Xzense App features
6. Signal test & software update
7. eXotelligence

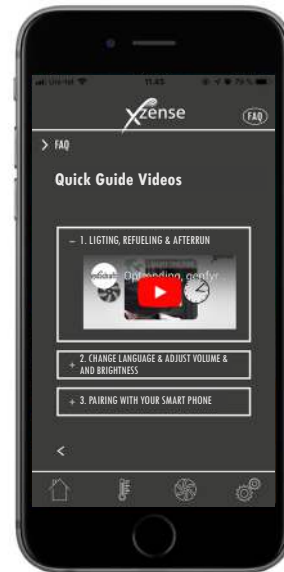

Software update

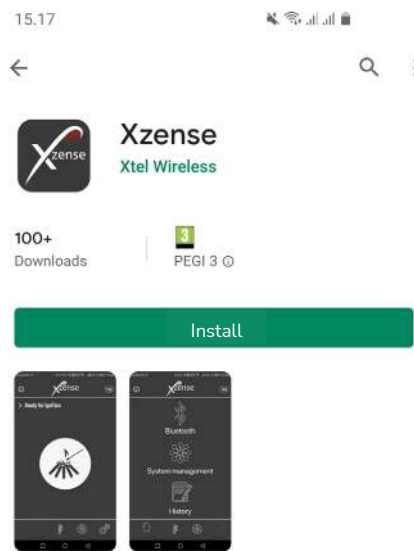
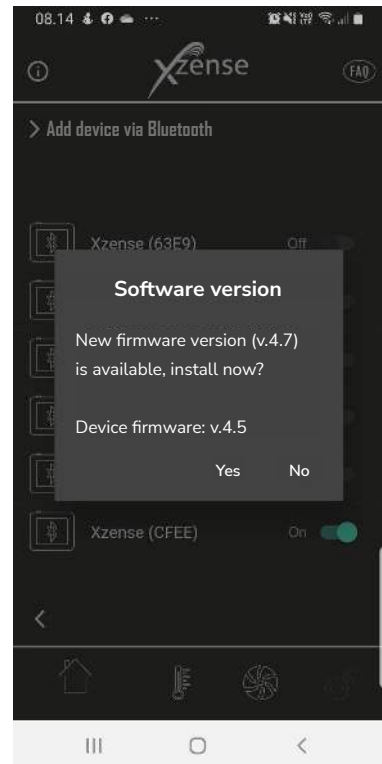
Step	Action	Display
1	Open Google Play/App Store on your phone and search for "Xzense". Install Xzense Android/iOS App version 4.13 or higher.	
2	On the Xzense control panel, access the submenu "Network" and select "Bluetooth". Activate Bluetooth to pair your Xzense with your smartphone via the Xzense app (see steps in the Xzense user manual – Chapter 2.14). It is possible to update the control panel firmware without first connecting it to a power unit.	
3	Once the control panel and phone app are paired, a dialog box will pop up on the phone and ask if you wish to install the latest firmware. Press "Yes". N.B. if this does not happen, press the (i) icon in the top left corner of the phone app.	

4

Wait while the phone transfers the firmware update to the Xzense control panel. This should take about 15 minutes. During this transfer process, do not shut down the phone or the control panel, and keep the devices within 3 metres of each other. Once the transfer is complete, the control panel will update itself (this should take roughly a minute).

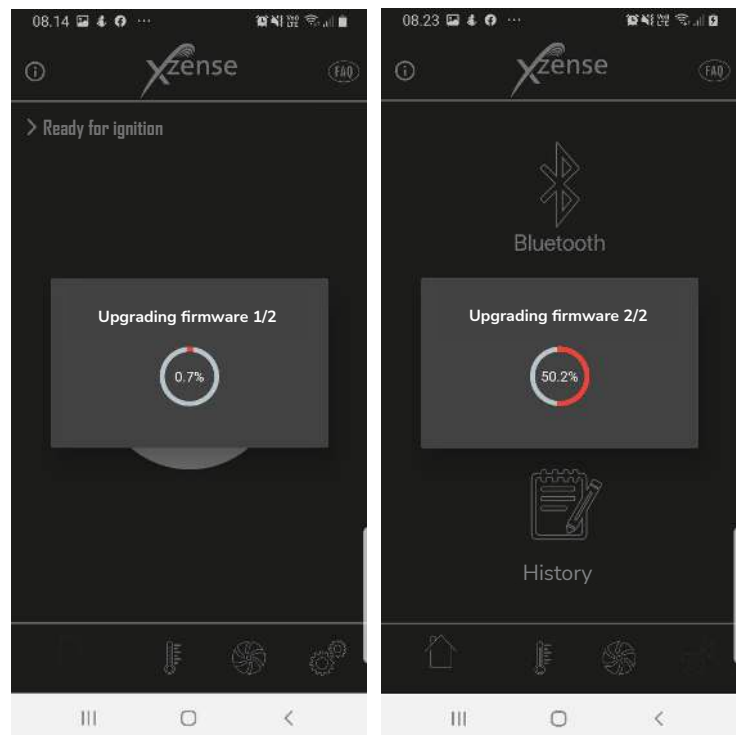

5

Once the Control panel is updated, the Power Unit will update automatically. This process takes approximately 40-50 minutes.



6

Once the Control panel has transferred the update to the Power Unit, the power unit will update itself (this should take roughly a minute).

After that, the control panel is ready to use.

Accessories - Repeater

A repeater must be ordered/purchased separately and are not included in an Xzense set of Control panel and Power Unit!

Setup - Mounting

The repeater makes it possible to obtain a signal if there is too much distance between the control panel and the power unit or if the signal has to pass through, for example, several storeys.

The signal can at most go through 3 pcs. repeaters between an Xzense power unit and a control panel. The repeater is placed between the Xzense control panel and the power unit, which is typically mounted on the chimney. In some situations, it would be appropriate to set up the repeater outdoors, eg under the overhang or on another building. The signal may have difficulties to get through certain materials, for example, steel and aluminum constructions.

Range

Range between units should not exceed 18 meters.

Setting up one repeater

In the example to the right is shown a control panel (2) at the stove, a power unit (3) on the chimney and a repeater (1).

Set up the repeater (1) somewhere between the power unit on the chimney and the control panel. The chimney fan can now be operated from the control panel.

NB! The repeater only needs to be connected to mains power to work correctly.

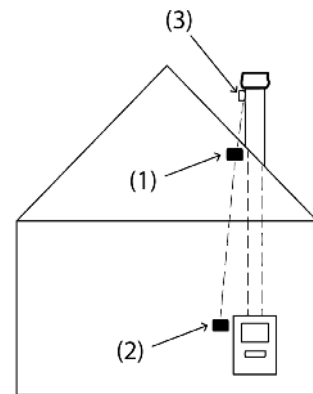

Setting up multiple repeater

In the example to the right is shown a control panel (2) at the stove, a power unit (3) on the chimney and 3 pcs. repeaters (1). The signal between the power unit and the control panel will go through all the repeaters here.

1. Location of first repeater (1). Use the control panel (2) to find the location that the signal can reach without a repeater.
2. Turn on the display and go to the Signal menu. Select Signal Test. The control panel now performs a signal test to ensure that there is an optimal signal between the control panel and the power unit.
3. Set up the repeater at the location where signal can still be obtained.

If more repeaters are required, follow the procedure in the above points.

The chimney fan can now be operated from the control panel.

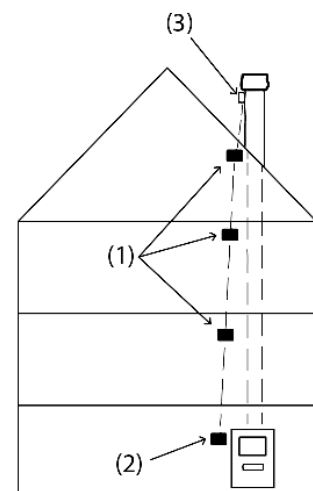

Technical data

Dimensions H x B x D [mm]	72 x 86 x 25
Input, supply	5 VDC - USB
Ingress protection	IP20
Material	Box: Black ABS - Lid: Black PC
Ambient temperature	-30 °C to 60 °C

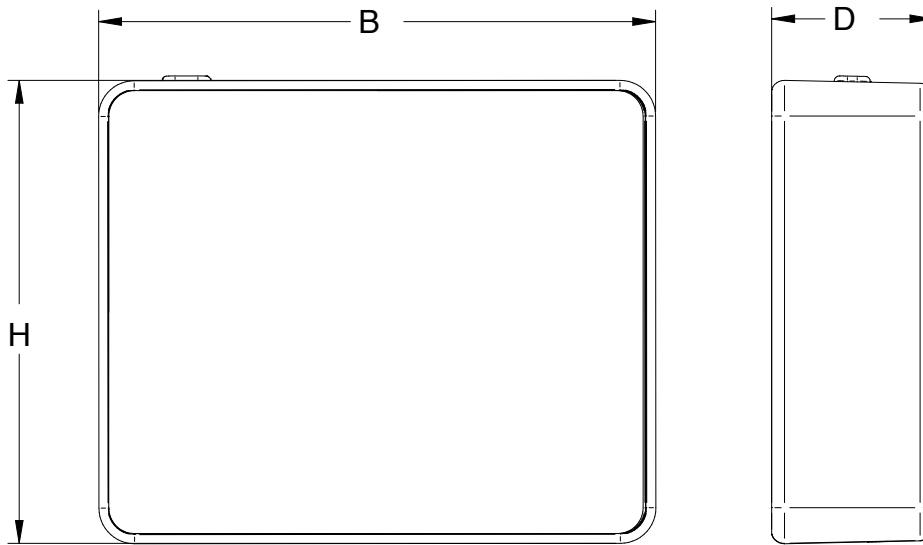

Accessories - XTP sensor

A XTP sensor must be ordered/purchased separately and are not included in an Xzense set of Control panel and Power Unit!

Setup - Mounting

The installation must be carried out by competent persons.

The XTP sensor makes it possible to achieve a constant draft in the chimney, thereby ensuring optimum combustion during firing.

Xzense XTP sensor must always be mounted with the hose connectors downwards (fig. 1).

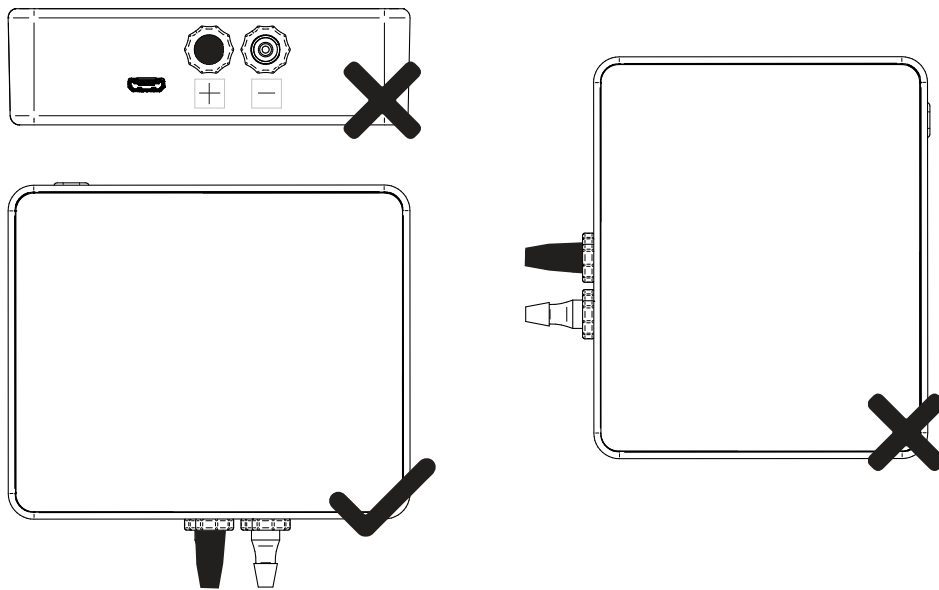

(fig. 1)

When underpressure measurement, the pressure hose is mounted on the (-) stud.
Overpressure stud (+) must keep the black cap on.







WARNING! Do not blow in the stud of an Xzense XTP sensor!

Electrical connection

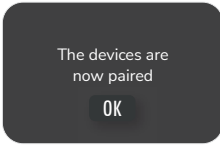

ATTENTION! All installations must be performed by competent persons in accordance with local laws and regulations.

Add device/pairing devices

Step	Action	Icon
1	To add a device (XTP sensor) to the control panel, select the <i>Add device</i> menu on the display.	 Add device
2	Already paired devices are displayed screen with a trash can. To pair with a new device, select a device with a link on it. Here, select the device XTP sensor. If prompted for a password, use "1 2 3 4"	 XTP-sensor
3	A dialog box appears and confirms that the pairing has been done correctly. Always make sure you have both power control panel and XTP sensor during pairing.	
4	To run with the XTP sensor's system control, this must be selected below the <i>System control</i> menu, located under the <i>Setup</i> menu.	 System control
5	Change system management from <i>Manual use</i> to <i>Pressure controlled use</i> by activating the ON function.	 Pressure controlled

Technical data

Working range	5 Pa - 150 Pa +/- 0,1% Full scale
Dimension (H x B x D) [mm]	75 x 85 x 25
Weight	120 g
Ingress protection	IP20
Material	Box: Black ABS - Lid: Black PC
Ambient temperature	-25 °C - +50 °C
Storage temperature	-25 °C - +50 °C
Input, supply	5 VDC - USB
Permitted overpressure	20000 Pa
Media	Air and flue gases

Technical specifications

Troubleshooting

Error message Overview

Types of errors	Description
Error 1 - "No connection to Power Unit"	Power Unit and control panel are too far apart.
Error 2 - "Temperature sensor missing"	The temperature sensor is not installed correctly or is malfunctioning.
Error 3 - "Temperature above 400°C!"	The temperature is too high in the chimney.
Error 4 - " No power to Power Unit!"	There is no power to the Power Unit.
Error 5 - " Not enough draft in the chimney"	There are not enough draft in the chimney to make it work optimally.
Error 6 - " Pressure sensor missing"	The pressure sensor is not installed correctly or has been lost connection to the device.
Error 7 - "Service Switch OFF"	The service switch is off (Power failure).
Error 8 - "Low Battery!"	The battery is low on power.
Error 9 - "Critical Low Battery!"	The battery has no power, and screen shuts down

Corrective Actions

If none of the following works, you can always try to restart the panel.

See how to restart the panel in section "General use of the control panel" on page 14.

Observation*	Action
No light in the display on the control panel when activated	Charge the control panel Press and hold the button for 10 sec with the charger plugged in.
Empty battery appears on the display	Charge the control panel
Announcement; "Battery low" in a dialog box	Charge the control panel
No draft in the chimney, but the display shows it is in operation	Check if the wing of the chimney fan is rotating Check if the chimney is blocked
The temperature does not appear in the display	Check the activation of the sensor in the menu
The chimney fan does not start or stop automatically	Check the activation of the sensor in the menu Check the start and stop temperatures under the Settings menu Check that the sensor is positioned correctly below the fan Replace the sensor, if it is necessary and defective
Announcement; "No signal" on the display	Check the control panel's distance from the Power Unit (max. 18 m). Place the control panel in a more optimal location (for example, if conversion has been made, the signal may have deteriorated). If a signal cannot be obtained, a repeater can be added to the network (see section 1.2 Accessories).
Announcement; "Warning! To high chimney temperature" on the display	Excessive chimney temperature - limit the combustion. Check the settings for the temperature in the Settings menu
Announcement; "No units added" on display	No devices have been added to the control panel (see section 2.10 Signal test and add / delete units).

***Note: All alarm views will disappear when the error is corrected. See the overview of troubleshooting under the Error Log menu.**

Updating the software

If you experience problems which is not listed above, then try to use a smartphone and the Xzense app to update the system.

User and service menu

Menu	Submenu	Type	Description	Factory setting
General				
	Interface			
	Language		Language selection shown in the menus: Danish, Swedish, Norwegian, German, English, French, Dutch, Polish and Finnish	English
	Contrast		Contrast from 0-100%	50%
	Brightness		Brightness from 0-100%	100%
	Sound		Sound from 0-100%	100%
	Setup			
	Start temperature		Automatic start when temperature sensor measures: 5-100 °C	40 °C
	Stop temperature		Automatic stop when temperature sensor measures: 0-95 °C	35 °C
	Boost time		Time setting at startup (Boost): 1-15 min.	10 min.
	Stop time (Afterrun)		Time setting at stop (Afterrun): 1-200 min	30 min.
	Boost speed		Boost speed from 40-100%	100%
	Chimney draft		Chimney draft from 8-60 Pa	20 Pa
	Minimum fan speed		Minimum voltage level: 80 -120 V. Note: Min. 100 V if the chimney fan is an RS009-41.	100 V
	External start			
	Factory reset		Restores all factory settings: Yes/No	No
	Error log		Displays errors and alarms with date	
	Software version		Displays software version for enabled units: control panel, power unit, repeater and pressure sensor	
	System control		Control systems in the unit: Manuel/eXotelligence/ Pressure controlled	Manual
	Temperature sensor		Activation of temperature sensor: On/Off	On
	Alarm setpoint		High temperature alarm deviation setting: 150-400 °C	250 °C
	Boost stop setpoint		Stop temperature for boost	150 °C

Menu	Submenu	Type	Description	Factory setting
	Network			
	Signal			
		Devices	Add power unit, repeater and pressure sensor	
		Signal test	Displays the status of the signal	
		Reset network	Deletes all included devices: Yes/No Note: Also deletes the power unit from the network	No
	Bluetooth			
		Enable Bluetooth	Activating Bluetooth function: On/Off	Off
Lightning				
	Lighting			
		Boosting	Boost time during lighting	10 min. at 100%
		Operation	Setting the speed at the current operating situation	50%
		Refueling	Possibility of refiring: Ja/Nej	35 °C
		Afterrun	Run time at the end of a burning cycle	30 min. at 50%
Ventilation				
	Start	Start the fan	Start fans (Start/Turn off): 0-100%	50%
	Stop	Turn off the fan	Turn off fans (Start/Turn off)	
Weather	Outdoor	Outdoor temperature	The current temperature outside	Variable
	Chimney	Chimney temperature	The current temperature in the chimney	Variable
	Air pressure	The air pressure outside	The current air pressure outside	Variable



UK Conformity Assessed

exodraft

**Exodraft a/s
Industrivej 10
DK-5550 Langeskov**

Hereby declares that the following products:

XZENSE, XZENSE-UK, XZENSE-DK

Were manufactured in conformity with the provisions of the following regulations:

The Supply of Machinery (Safety) Regulations 2008

Electrical Equipment (Safety) Regulations 2016

Electromagnetic Compatibility Regulations 2016

Radio Equipment Regulations 2017

Langeskov, 01-11-2022

Managing Director
Anders Haugaard



Declaration of Conformity

DK: EU-Overensstemmelseserklæring
GB: Declaration of Conformity
DE: EU-Konformitätserklärung
FR: Déclaration de conformité de l'Union Européenne
NO: EU-Samsvarserklæring
PL: EU Deklaracja zgodności

NL: EU-Conformiteits verklaring
SE: EU-Överensstämmelsedeklaration
FI: EU-Vaatimustenmukaisuusvakuutus
IS: ESS-Samræmisstaðfesting
IT: Dichiarazione di Conformità Unione Europea

exodraft

**Exodraft a/s
Industrivej 10
DK-5550 Langeskov**

Erklærer på eget ansvar, at følgende produkter:
Hereby declares that the following products:
Erklært hierdurch auf eigene Verantwortung, daß folgende Produkte:
Déclare, sous sa propre responsabilité, que les produits suivants:
Erklærer på eget ansvar at følgende produkter:
Niniejszym oświadczam, że następujące produkty:

Veklaart dat onderstaande producten:
Deklarerar på eget ansvar, att följande produkter:
Vastaa siltä, että seuraava tuote:
Staðfesti à eigin àbyrgð, að eftirfarandi vörur:
Dichiara con la presente che i seguenti prodotti:

XZENSE, XZENSE-UK, XZENSE-DK

Som er omfattet af denne erklæring, er i overensstemmelse med følgende standarder:
Were manufactured in conformity with the provisions of the following standards:
Die von dieser Erklärung umfaßt sind, den folgenden Normen:
Auxquels s'applique cette déclaration sont en conformité avec les normes ci-contre:
Som er omfattet av denne erklæring, er i samsvar med følgende standarder:
Zostały wyprodukowane zgodnie z warunkami określonymi w następujących normach:

Zijn vervaardigd in overeenstemming met de voorschriften uit de hieronder genoemde normen en standaards:
Som omfattas av denna deklaration, överensstämmer med följande standarder:
Jota tämä selvitys koskee, on seuraavien standardien mukainen:
Sem eru meðtalin í staðfestingu Pessari, eru í fullu samræmi við eftirtalda staðla:
Sono stati fabbricati in conformità con le norme degli standard seguenti:

EN 60335-1, EN 60335-2-80, DS/EN ISO 12100: 2011

I.h.t bestemmelser i direktiv:
In accordance with
Entsprechen gemäß den Bestimmungen der folgenden Richtlinien:
Suivant les dispositions prévues aux directives:
I.h.t bestemmelser i direktiv:
Zgodnie z:

En voldoen aan de volgende richtlijnen:
Enligt bestämmelserna i följande direktiv:
Seuraavien direktiivien määräysten mukaan:
Med tilvisun til ákvarðana eftirlits:
In conformità con le direttive:

Maskindirektivet:
The Machinery Directive:
Richtlinie Maschinen:
Directive Machines:
Maskindirektivet:
Dyrektywę maszynową:

De machinerichtlijn:
Maskindirektivet
Konedirektiivi:
Vèlaeftirlitið:
Direttiva Macchinari:

2006/42/EF-EEC-EWG-CEE

Lavspændingsdirektiv:
The Low Voltage Directive:
Niederspannungsrichtlinie:
Directive Basse Tension:
Lavspenningsdirektivet:
Dyrektywę Niskonapięciową

De laagspanningsrichtlijn:
Lågspänningsdirektivet:
Pienjännitedirektiivi:
Smáspennueftirlitið:
Direttiva Basso Voltaggio:

2014/35/EC

EMC-direktivet:
And the EMC Directive:
EMV-Richtlinie:
Directive Compatibilité Electromagnétique:
EMC-direktivet:
Dyrektywę EMC – kompatybilności elektromagnetycznej

En de EMC richtlijn:
EMC-direktivet:
EMC-direktiivi:
EMC-efirlitið:
Direttiva Compatibilità Elettromagnetica:

2014/30/EC

Langeskov, 01-11-2022
Adm. direktør
Managing Director
Anders Haugaard

Algemeen directeur
Geschäftsführender Direktor
Président Directeur Général
Verkställande direktör
Toimitusjohtaja
Frankvemdastjóri
Direttore Generale

DK: Exodraft a/s

Industrivej 10
DK-5550 Langeskov
Tel: +45 7010 2234
Fax: +45 7010 2235
info@exodraft.dk
www.exodraft.dk

SE: Exodraft a/s

Kalendevägen 2
SE-302 39 Halmstad
Tel: +46 (0)8-5000 1520
info@exodraft.se
www.exodraft.se

NO: Exodraft a/s

Storgaten 88
NO-3060 Svelvik
Tel: +47 3329 7062
info@exodraft.no
www.exodraft.no

UK: Exodraft Ltd.

24 Janes Meadow, Tarleton
GB-Preston PR4 6ND
Tel: +44 (0)1494 465 166
Fax: +44 (0)1494 465 163
info@exodraft.co.uk
www.exodraft.co.uk

DE: Exodraft a/s

Niederlassung Deutschland
Soonwaldstr. 6
DE-55569 Monzingen
Tel: +49 (0)6751 855 599-0
Fax: +49 (0)6751 855 599-9
info@exodraft.de
www.exodraft.de

FR: Exodraft sas

78, rue Paul Jozon
FR-77300 Fontainebleau
Tel: +33 (0)6 3852 3860
info@exodraft.fr
www.exodraft.fr

Your energy. Optimized.

The logo for Exodraft, featuring the word "exodraft" in a bold, lowercase sans-serif font. The letter "x" is stylized with a curved line that loops around the top and bottom of the letter, suggesting motion or energy.